

# Bridge rectifiers

## Feature

- . Plastic Package has Underwriters Laboratory Flammability Classification 94V-0
- . Glass passivated chip junctions
- . Surge overload rating of 30 Amperes peak
- . Ideal for printed circuit board

## MECHANICAL DATA

- . Case: Molded plastic
- . Weight: 0.02 ounce,0.5 gram
- . High temperature soldering guaranteed : 260 /10seconds
- . We declare that the material of product compliance with RoHS requirements.

**DB102 Thru DB107  
DF01 Thru DF10**

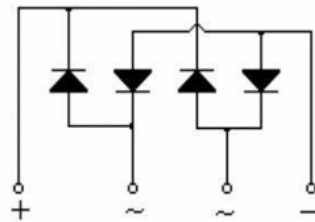
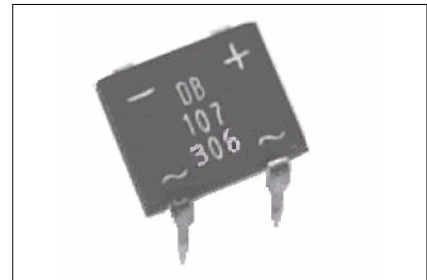

Circuit Diagram

## Product Characteristic

Parameter Symbol	Symbol	DB102	DB103	DB104	DB105	DB106	DB107	Unit
		DF01	DF02	DF04	DF06	DF08	DF10	
Maximum repetitive voltage	$V_{RM}$	100	200	400	600	800	1000	V
Maximum DC reverse current at rated DC blocking voltage	$I_R$	10						$\mu A$
		500						
Average rectified forward current 60Hz Sine wave Resistance load with heat sink $T_c=100$	$I_o$	1						A
Peak forward surge current 8.3ms single half sine-wave superimposed on rated load	$I_{FSM}$	50						A
Maximum instantaneous forward voltage at 1A	$V_F$	1.1						V
Operating junction temperature	$T_J$	125						
Storage temperature	$T_{stg}$	-40~150						

## Characteristic Curves

Fig. 1 Derating Curve

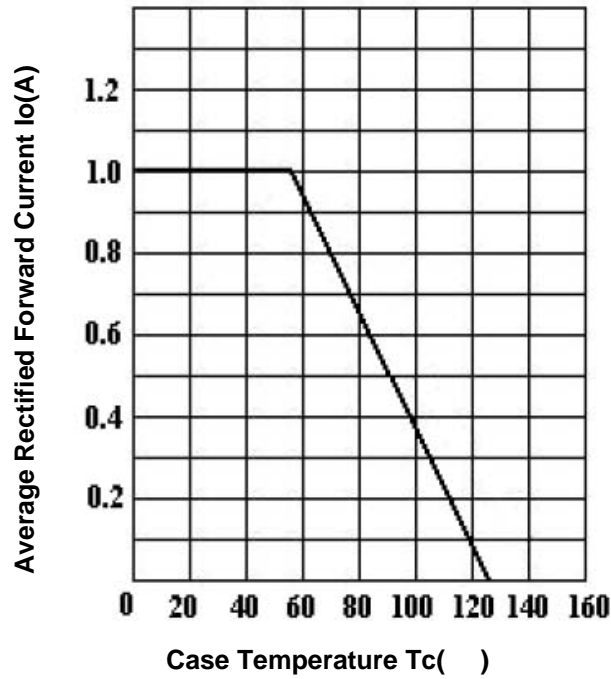

Fig.2 Typical Reverse Characteristics

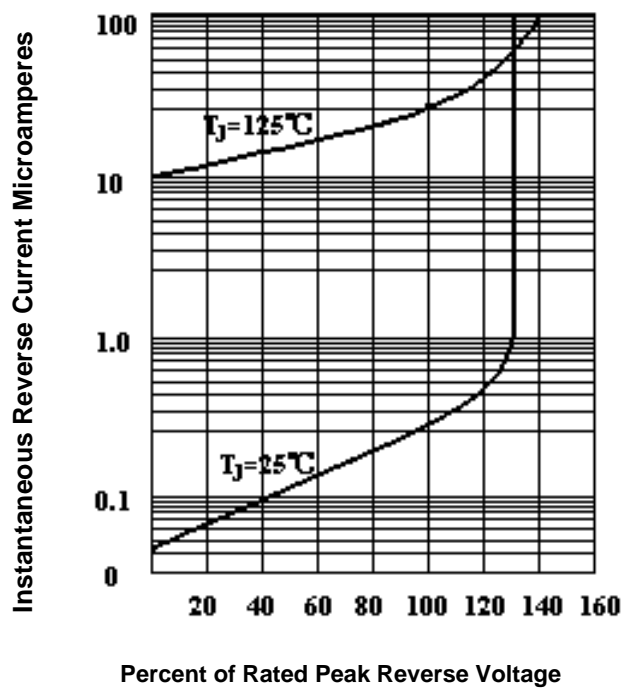

Fig.3 Peak Surge Forward capability

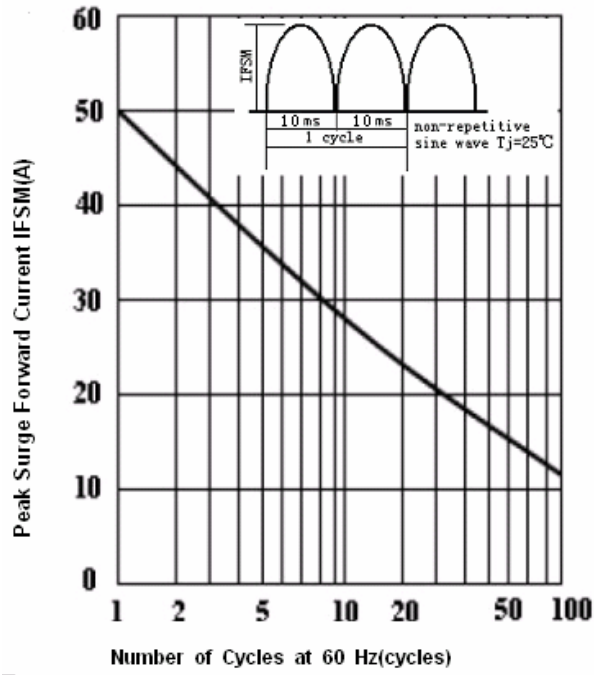
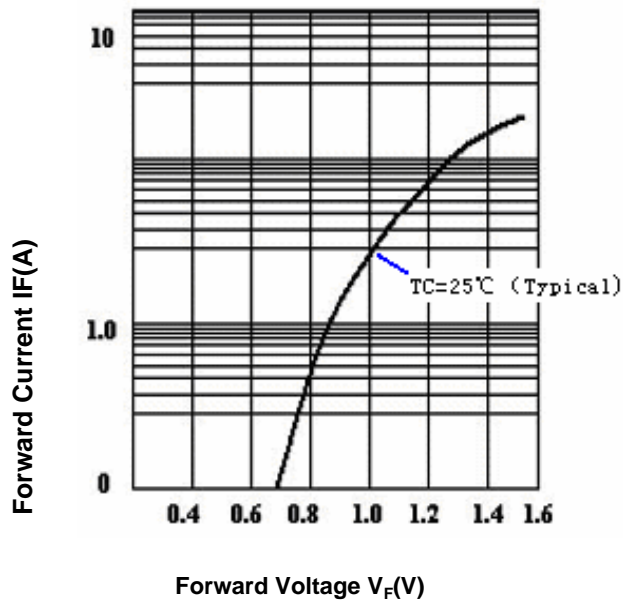
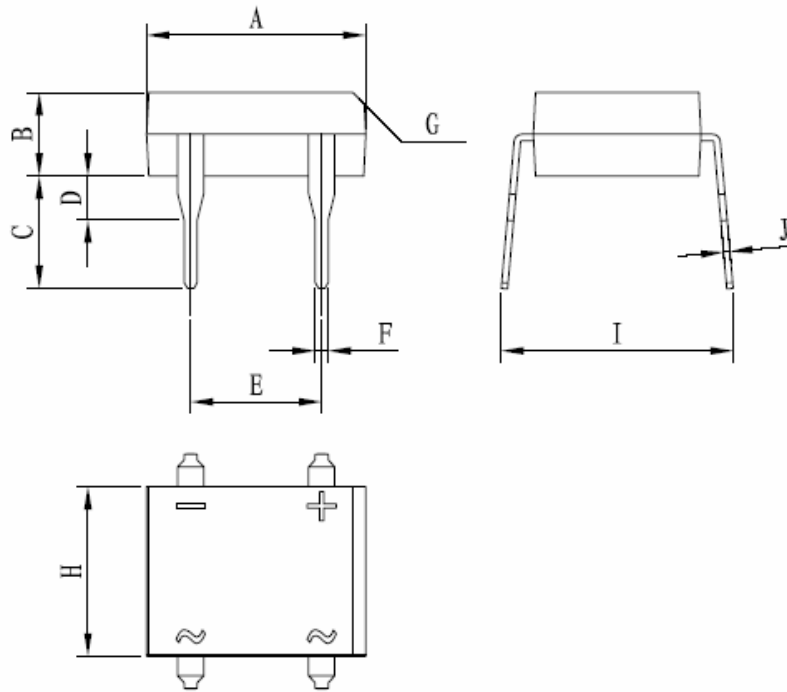

Fig.4 Forward Voltage



## SHAPE AND DIMENSIONS



DIM	INCHES		MILLIMETERS	
	MIN	MAX	MIN	MAX
A	0.319	0.335	8.10	8.50
B	0.118	0.134	3.00	3.40
C	0.165	0.173	4.20	4.40
D	0.063	0.071	1.60	1.80
E	0.192	0.208	4.88	5.28
F	0.016	0.024	0.41	0.61
G	0.039*45°		1*45°	
H	0.244	0.260	6.20	6.60
I	0.335	0.374	8.50	9.50
J	0.01	0.01	0.20	0.30

- NOTES: 1. DIMENSIONING AND TOLERANCING PER ANSII Y14.5M, 1982.  
2. CONTROLLING DIMENSION: mm.